

# ADSC04.99

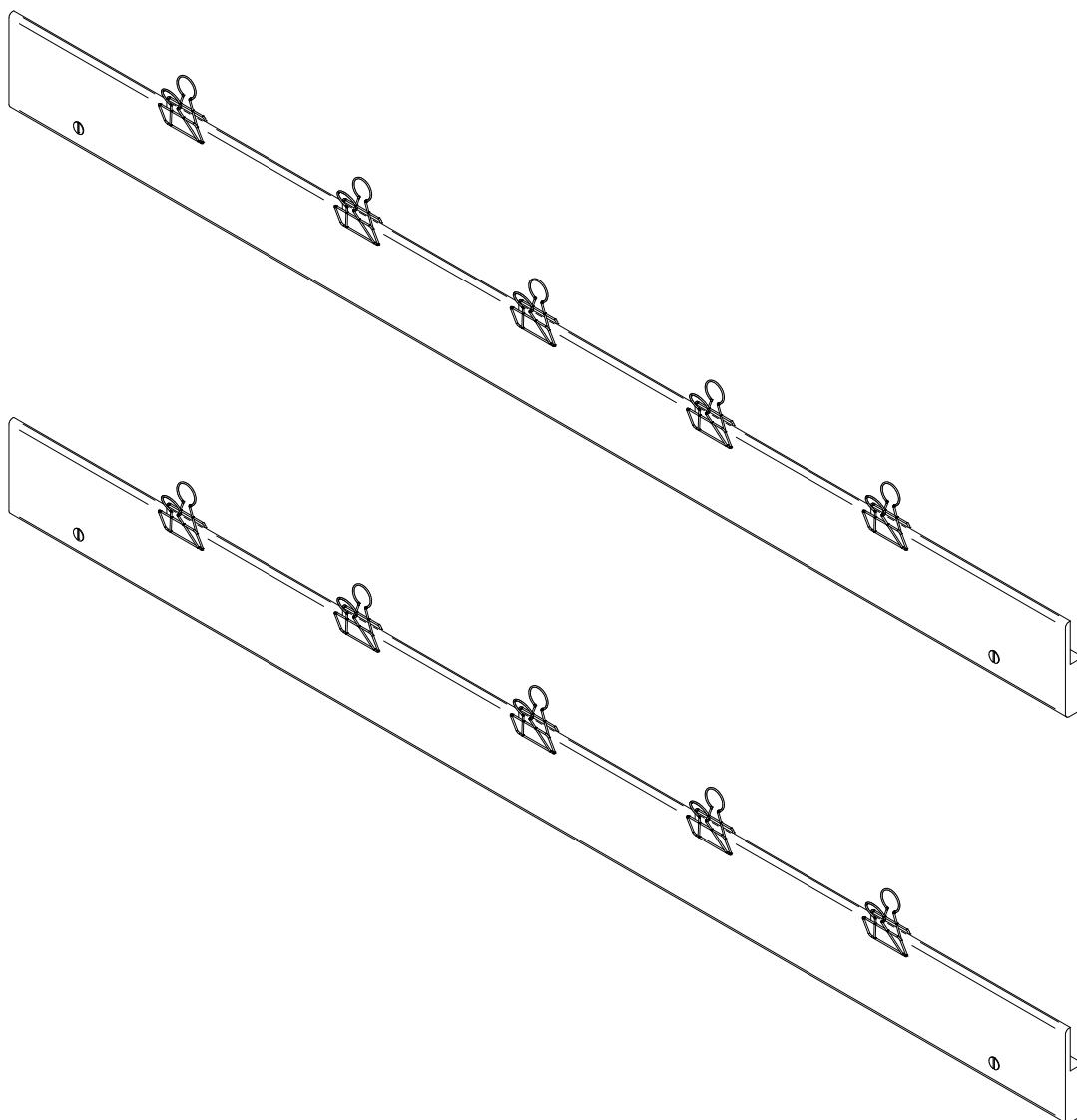

**ASTIGARRAGA**  
*kit line*

# FR MONTAGE ES MONTAJE IT MONTAGGIO DE BEDIENUNGSANLEITUNG EN ASSEMBLY PT MONTAGEM

## FR NOUS VOUS CONSEILLONS

- Poser les colis en position horizontale
- Classer et compter les éléments de montage et la quincaillerie
- Définir une zone de montage
- Suivre dans l'ordre les instructions de montage

## ES TE ACONSEJAMOS

- Poner el paquete en posición horizontal
- Ordenar y contar las piezas y herrajes
- Habilita una zona para el montaje
- Sigue paso a paso las instrucciones de montaje

## IT VI INFORMIAMO

- Porre la confezione in orizzontale
- Mettere in ordine e contare le minuterie metaliche
- Essere certi di avere spazio a per il montaggio
- Seguire passo passo le istruzioni

## DE WIR RATEN IHNEN

- Legen Sie das Paket in eine horizontale Position, bevor Sie es öffnen
- Ordnen und zählen Sie die Teile und Beschläge
- Richten Sie einen Platz für die Montage ein
- Folgen Sie die Montageanleitung Schritt für Schritt

## EN I ADVISE YOU

- Put the package in horizontal position
- Put in the order and count the pieces and iron fittings
- Take enough space for assembly
- Follow step by step the assembly instruction

## PT ACONSELHAMO-LO A

- Colocar a embalagem na horizontal
- Ordenar e contar as peças e acessórios
- Preparar um local para a montagem
- Seguir passo a passo as instruções de montagem

FR Outils de montage nécessaires (not inclus dans le kit)

ES Las herramientas que necesitas (no incluidas en el kit)

IT Gli attrezzi che vi servono per il montaggio (non inclusi nella confezione)

DE Erforderliches Werkzeug (nicht im Bausatz enthalten)

EN The tools that you need for assembly (not included in the package)

PT As ferramentas de que necessita (não incluídas no kit)

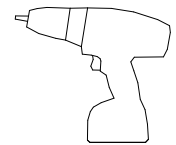

FR Quincaillerie incluse dans le kit

ES Los herrajes que encontrarás en el kit

IT Accessori inclusi nella confezione

DE Die Beschläge, die Sie im Bausatz finden

EN The tools that you will find in the package

PT Os acessórios que encontrará no kit

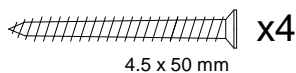

4.5 x 50 mm

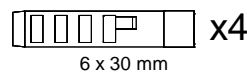

6 x 30 mm

FR Pièces incluses dans le kit

ES Las piezas incluidas en el kit

IT Parti incluse nella confezione

DE Die im Bausatz enthalten Teile

EN The pieces included in the package

PT Peças incluídas no kit

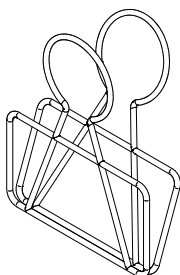

x10

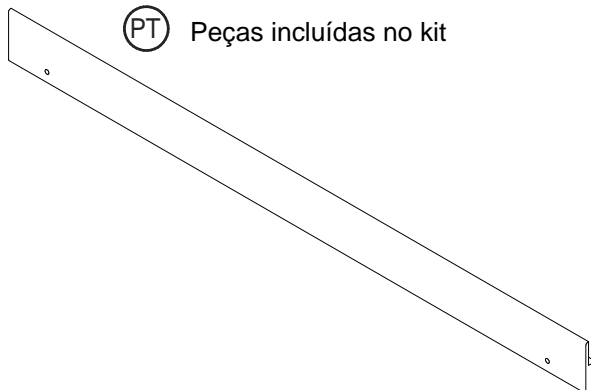

x2

# 1

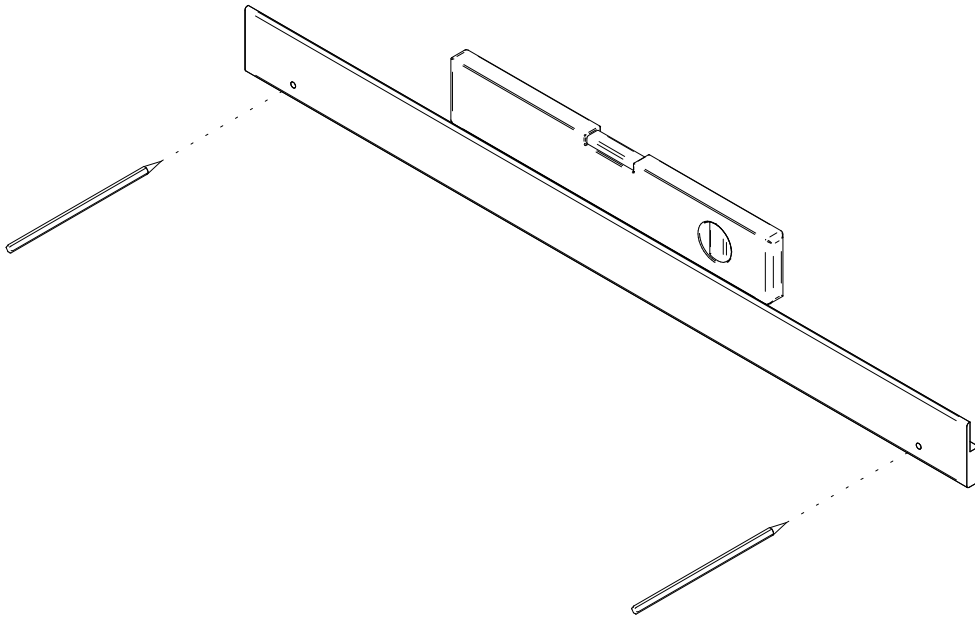

x2

# 2

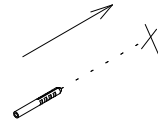
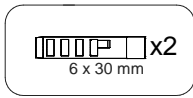
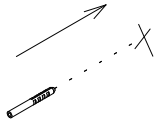

x2

# 3

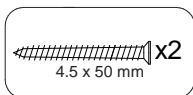
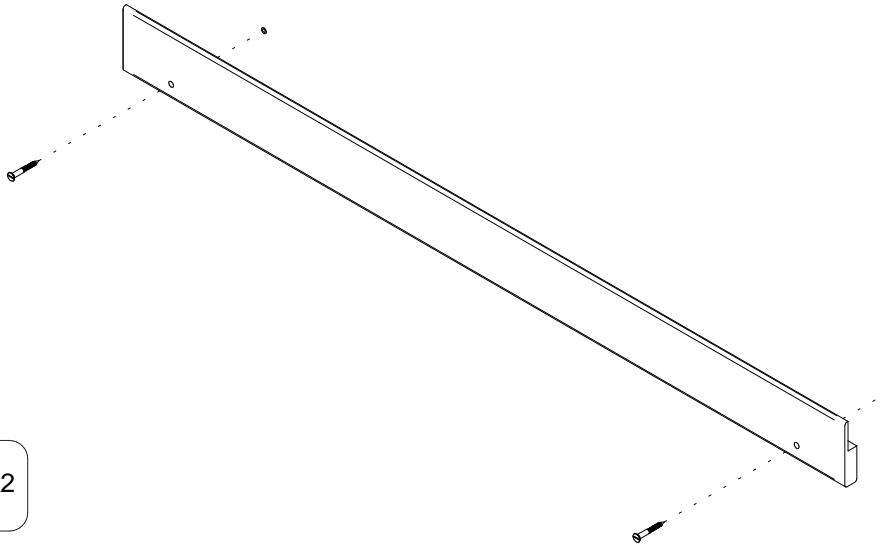

x2

4

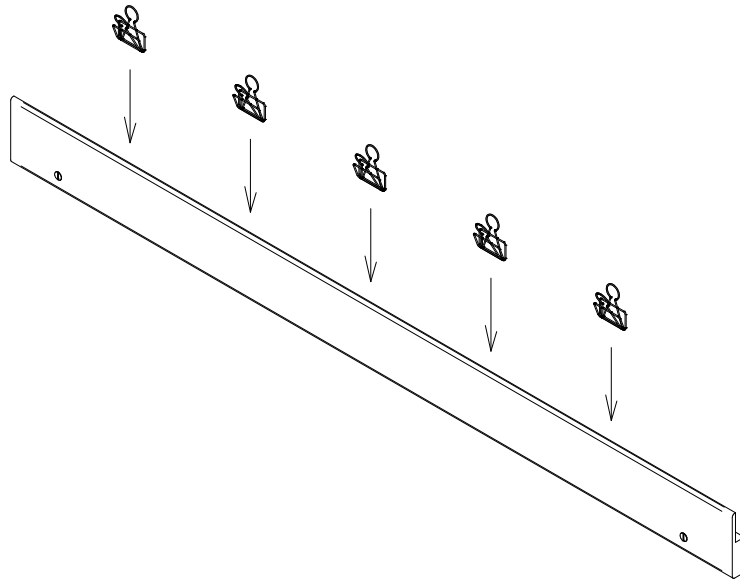

x2

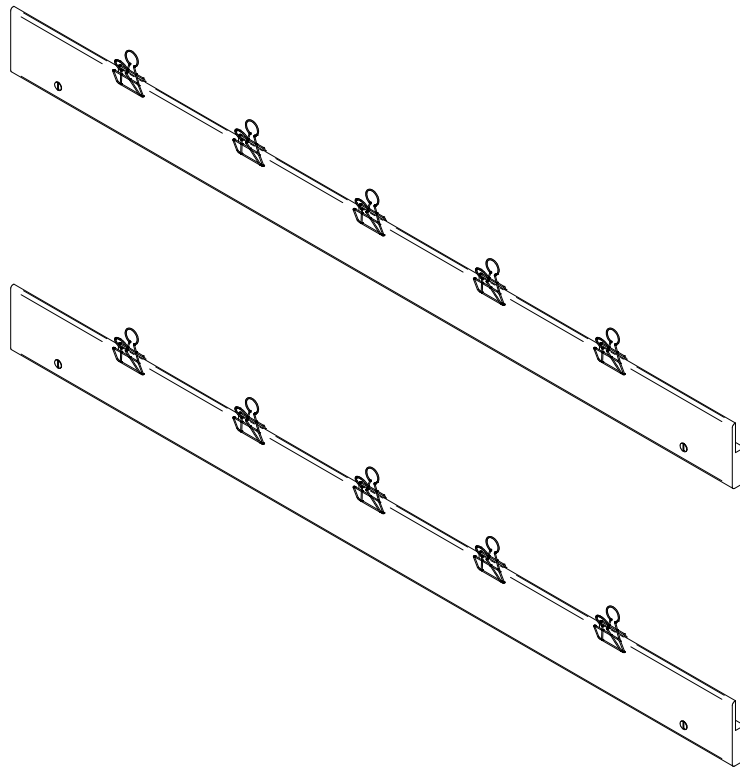

ref.ADSC04.99

- Ⓡ RECOMMANDATIONS D'UTILISATION ET GARANTIE
- Ⓔ RECOMENDACIONES DE USO Y GARANTÍA
- Ⓡ RACCOMANDAZIONI PER L'USO E LA GARANZIA
- Ⓓ EMPFEHLUNGEN ZUR VERWENDUNG UND GARANTIE
- Ⓔ RECOMMENDATIONS FOR USE AND WARRANTY
- Ⓡ RECOMENDAÇÕES DE UTILIZAÇÃO E GARANTIA



Ⓡ AVERTISSEMENT!

Cette fresque doit être fixée au mur à l'aide du matériel de fixation fourni. Les vis et chevilles fournies ne peuvent être utilisées que sur des murs en briques. Utilisez des vis et des chevilles adaptées à vos murs. En cas de doute, demandez l'avis d'un professionnel.

Ⓔ ¡ADVERTENCIA!

Este mural se debe unir a la pared con los herrajes de fijación a pared que se incluyen. Se incluyen tornillos y tacos de pared únicamente utilizables en paredes de ladrillo. Utiliza tornillos y tacos adecuados para tus paredes. En caso de duda, busca asesoramiento profesional.

Ⓡ ATTENZIONE!

Questo murale deve essere fissato alla parete utilizzando la ferramenta per il fissaggio a muro in dotazione. Le viti e i tasselli sono inclusi e possono essere utilizzati solo su pareti in mattoni. Utilizzare viti e tasselli adatti alle proprie pareti. In caso di dubbio, rivolgersi a un professionista.

Ⓓ WARNUNG!

Dieses Wandbild muss mit dem mitgelieferten Befestigungsmaterial an der Wand befestigt werden. Die mitgelieferten Schrauben und Dübel sind nur für die Verwendung in Ziegelwänden geeignet. Verwenden Sie Schrauben und Dübel, die für Ihre Wände geeignet sind. Lassen Sie sich im Zweifelsfall von einem Fachmann beraten.

Ⓔ WARNING!

This mural must be attached to the wall using the wall fixing hardware provided. Screws and wall plugs are included and can only be used on brick walls. Use screws and wall plugs suitable for your walls. If in doubt, seek professional advice.

Ⓡ ATENÇÃO!

Esta mural tem de ser fixada à parede utilizando o material de fixação à parede fornecido. Os parafusos e as buchas estão incluídos e só podem ser utilizados em paredes de tijolo. Utilize parafusos e buchas adequados às suas paredes. Em caso de dúvida, procure aconselhamento profissional..



Olalde Area N°3  
20730 Azpeitia (Gipuzkoa)  
Tel. +34 943 814 261 - Fax +34 943 816 713  
info@astikitline.es  
www.astikitline.com

